

- 91.5%
- 
- 4kV 6kV
- 
- IP67
- SELV
- 5



EBV-060SxxxSVF

60W IP67

176-305Vac

	(1)		(2)	(3)	220Vac	
24 V	176 ~ 305 Vac 190 ~ 250 Vdc	0 ~ 2.5 A	60 W	88.5%	0.96	EBV-060S024SVF
36 V	176 ~ 305 Vac 190 ~ 250 Vdc	0 ~ 1.7 A	60 W	89.5%	0.96	EBV-060S036SVF
48 V	176 ~ 305 Vac 190 ~ 250 Vdc	0 ~ 1.25 A	60 W	91.5%	0.96	EBV-060S048SVF

1	CCC	220/230/240Vac;	CCC	200-240Vac		
2		90-305Vac	90-176Vac		"	"
3	220Vac	100%		"	"	

	176 Vac	-	305 Vac	190 ~ 250 Vdc
	47 Hz	-	63 Hz	
	-	-	0.70 mA	IEC60598-1; 240Vac/60Hz
	-	-	0.34 A	220Vac 100%
I <sup>2</sup> t	-	-	0.03 A <sup>2</sup> s	220Vac 25 10%Ipk-10%Ipk = 1.6 μs

	0.9	-	-	220-240Vac, 50-60Hz, 75%-100% (45~60W)
	-	-	10%	

	-5%Vo	-	5%Vo	100%
(pk-avg) EBV-060S024SVF EBV-060S036SVF EBV-060S048SVF	-	-	2.0 V 2.5 V 2.5 V	0% - 100% 20MHz 0.1μF 47μF
	-	-	5%Vo	100%
	-	-	±1%	100%
	-	-	±3%	
	-	-	0.5 s	220Vac 100%
	-	-	8%Vo	/ 1 A/μs 25% ~ 100%
	-	-	10 ms	
	-	0.03%/°C	-	= 0°C~Tc

25°C

@220Vac: EBV-060S024SVF EBV-060S036SVF EBV-060S048SVF	86.5% 87.5% 89.5%	88.5% 89.5% 91.5%	- - -	100% 25°
	-	1171,000 Hours	-	220 Vac 25 80% (MIL- HDBK-217F)
	-	99,000 Hours	-	220 Vac 80% 70
	-40°C	-	+90°C	
	-40°C	-	+75°C	5 10% RH to 100% RH
	-40°C	-	+85°C	5%RH to 100%RH

(L × W × H)	6.46 x 1.57 x 0.98			7.28 x 1.57 x 0.98
(L × W × H)	164 x 40.0 x 25.0			185 x 40.0 x 25.0
	-	390 g	-	

25°C

CE	EN 61347-1, EN61347-2-13
CB	IEC 61347-1, IEC 61347-2-13
CCC	GB 19510.1, GB 19510.14
KS	KS C 7655
<b>EMI</b>	
EN 55015/GB 17743 <sup>(1)</sup>	Conducted emission Test & Radiated emission Test
EN 61000-3-2/GB 17625.1	Harmonic current emissions
EN 61000-3-3	Voltage fluctuations & flicker
<b>EMS</b>	
EN 61000-4-2	Electrostatic Discharge (ESD): 8 kV air discharge, 4 kV contact discharge
EN 61000-4-3	Radio-Frequency Electromagnetic Field Susceptibility Test-RS
EN 61000-4-4	Electrical Fast Transient / Burst-EFT
EN 61000-4-5	Surge Immunity Test: AC Power Line: Differential Mode 4 kV, Common Mode 6 kV
EN 61000-4-6	Conducted Radio Frequency Disturbances Test-CS
EN 61000-4-8	Power Frequency Magnetic Field Test
EN 61000-4-11	Voltage Dips
EN 61547	Electromagnetic Immunity Requirements Applies To Lighting Equipment

1 EMI

( ) EMI

降额曲线

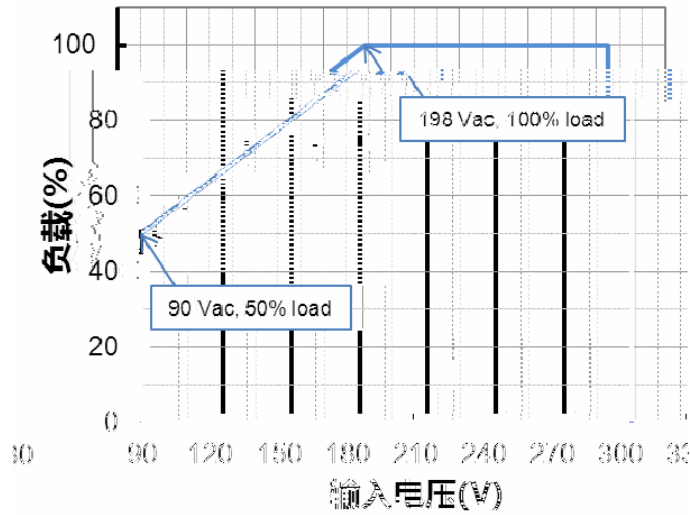

寿命 vs. 壳温

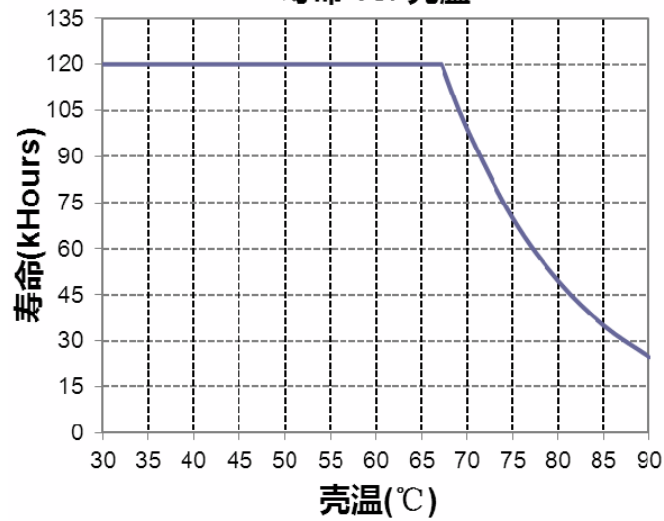

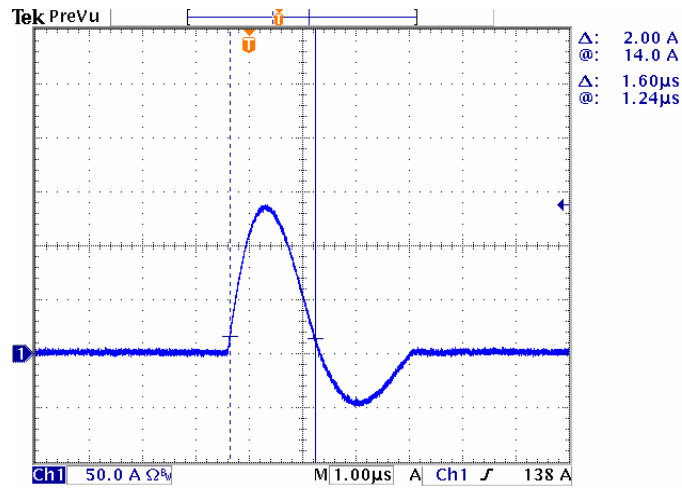

EBV-060S024SVF  
效率 vs. 输出电流

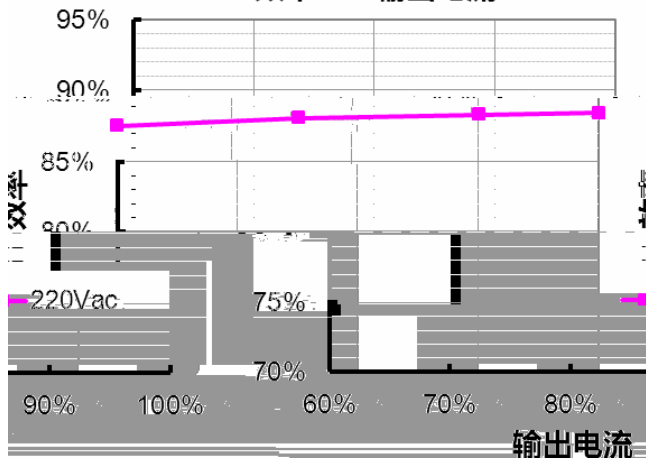

EBV-060S036SVF  
效率 vs. 输出电流

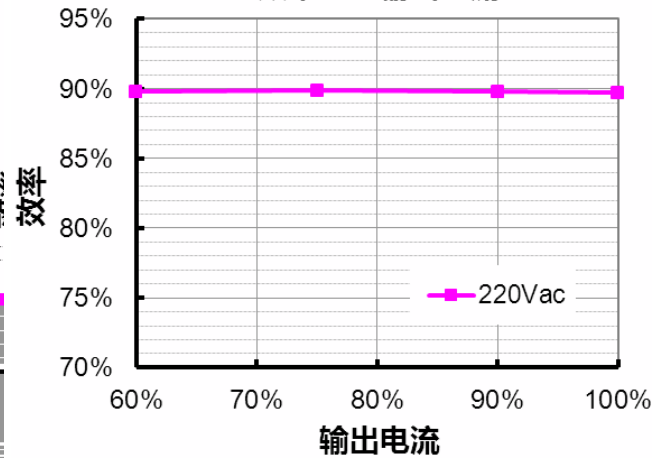

EBV-060S048SVF  
效率 vs. 输出电流

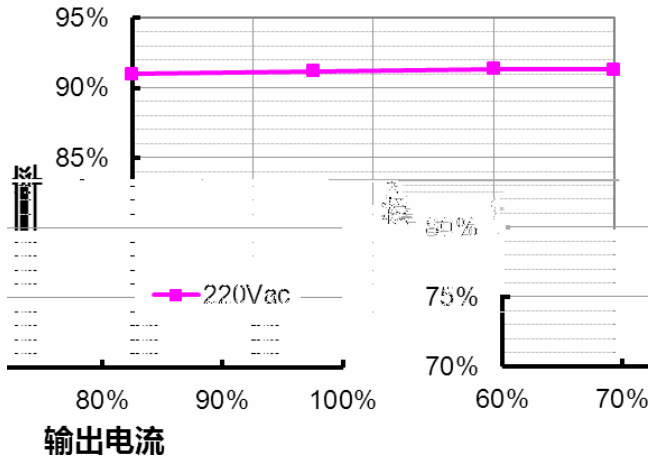

功率因数 vs. 负载

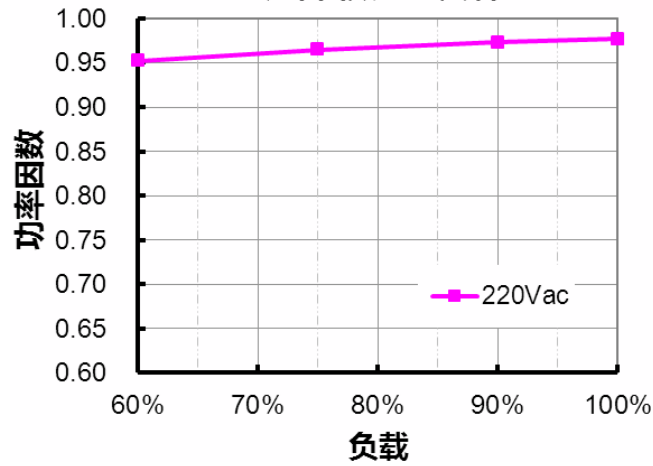

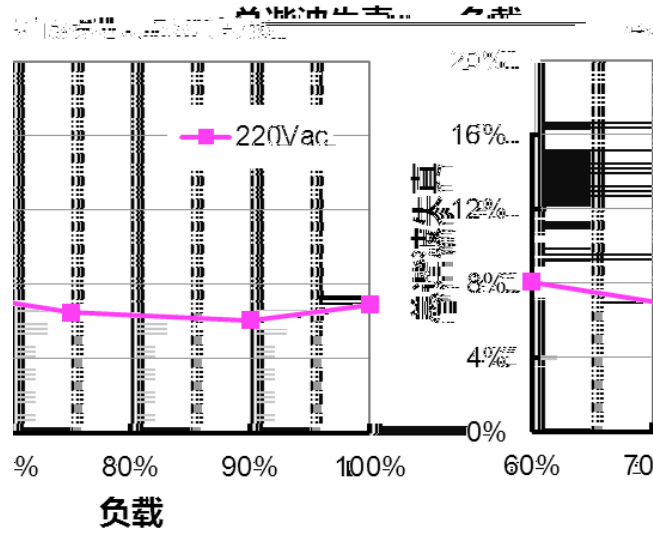

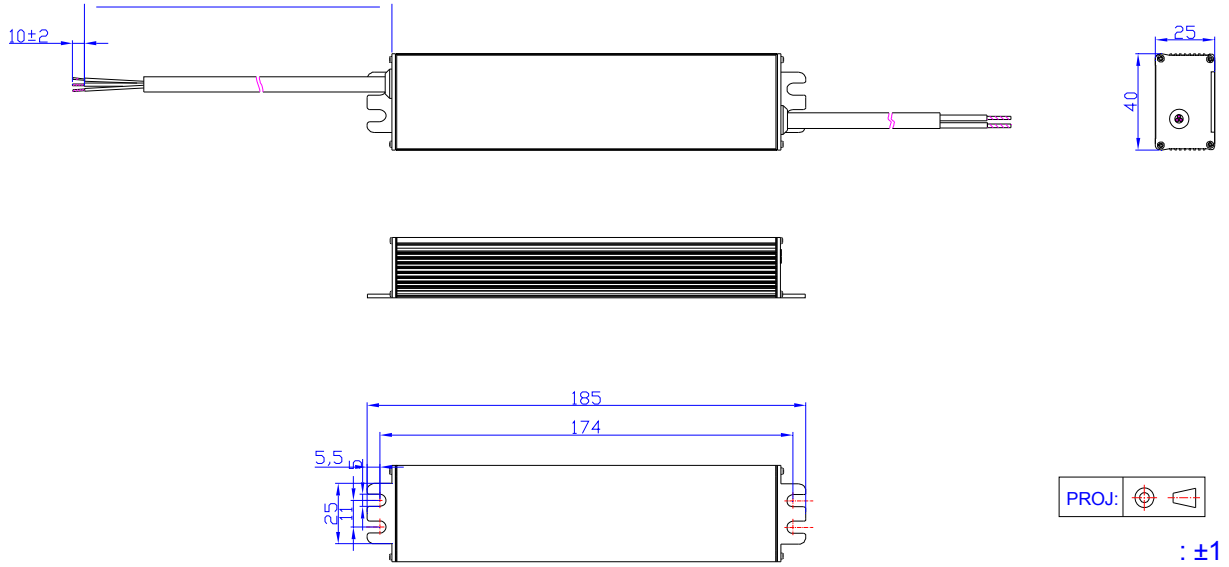

2019-08-09	A		/	/
2019-08-14	B		871,000Hours	1171,000Hours