

-
-
-
-
-
-
-
-



	1			2			3
12 Vdc	90 ~ 305 Vac	0~15.0 A	180 W	91.0%	0.99	0.97	EUV-200S012ST
24 Vdc	90 ~ 305 Vac	0~8.33 A	200 W	92.0%	0.99	0.97	EUV-200S024ST
36 Vdc	90 ~ 305 Vac	0~5.56 A	200 W	92.0%	0.99	0.97	EUV-200S036ST
42 Vdc	90 ~ 305 Vac	0~4.76 A	200 W	92.5%	0.99	0.97	EUV-200S042ST
48 Vdc	90 ~ 305 Vac	0~4.17 A	200 W	92.5%	0.99	0.97	EUV-200S048ST
54 Vdc	90 ~ 305 Vac	0~3.70 A	200 W	92.5%	0.99	0.97	EUV-200S054ST

			0.75 MIU	
			0.70 mA	

	-	-	2.5 A	
	-	-	1.1 A	
	-	-	1.5 A ² s	
	0.90	-	-	
	-	-	20%	

	-2.5%		2.5%	EUV-200S042ST,
	-5%	-	5%	
	-	-	2% V _o	
	-	-	10%	
	-	-	± 1%	
	-	-	± 2%	
	-	0.9 s	1.5 s	
	-	0.5 s	1.0 s	
	-	-	5% V _o	
	-	-	10 mS	
	-	0.05%/°C	-	0°C~

@110Vac				
V _o = 12 V	88.0%	89.0%	-	
V _o = 24 V	89.0%	90.0%	-	
V _o = 36 V	89.0%	90.0%	-	
V _o = 42 V	89.5%	90.5%	-	
V _o = 48 V	89.5%	90.5%	-	
V _o = 54 V	89.5%	90.5%	-	

INVENTRONICS

EUV-200SxxxST

Rev. R

200W IP67

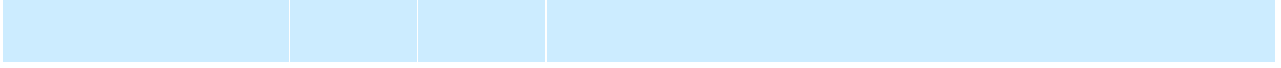

EMS	
EN 61000-4-4	Electrical Fast Transient / Burst-EFT
EN 61000-4-5	Surge Immunity Test: AC Power Line: Differential Mode 4 kV, Common Mode 6 kV ⁽²⁾
EN 61000-4-6	Conducted Radio Frequency Disturbances Test-CS
EN 61000-4-8	Power Frequency Magnetic Field Test
EN 61000-4-11	Voltage Dips
EN 61547	Electromagnetic Immunity Requirements Applies To Lighting Equipment

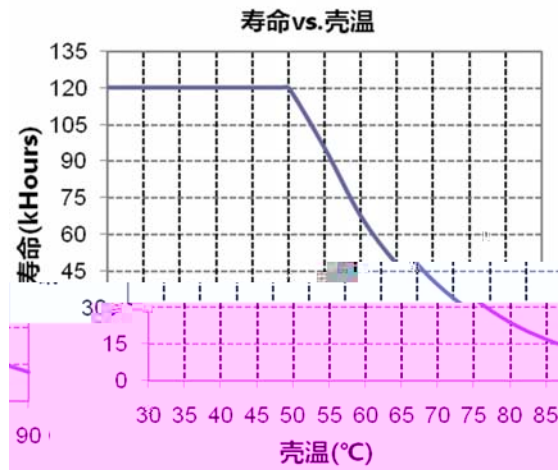

效率 vs. 输出电压(12V)

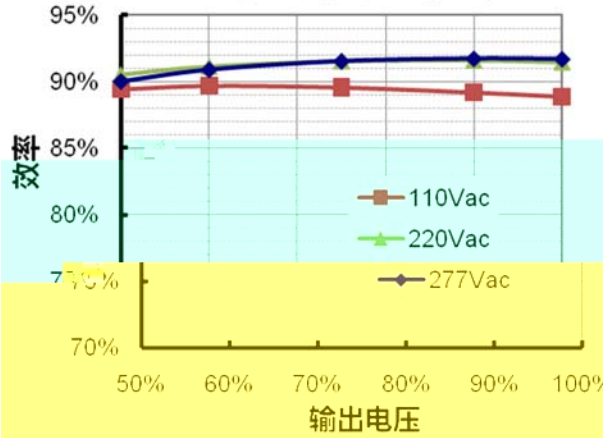

效率 vs. 输出电压(24V)

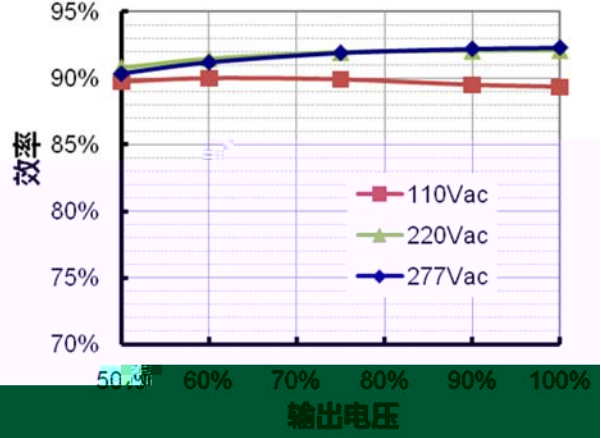

效率 vs. 输出电压(36V)

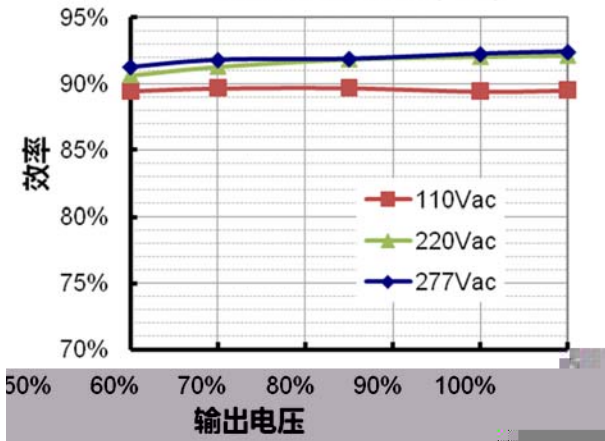

效率 vs. 输出电压(42V)

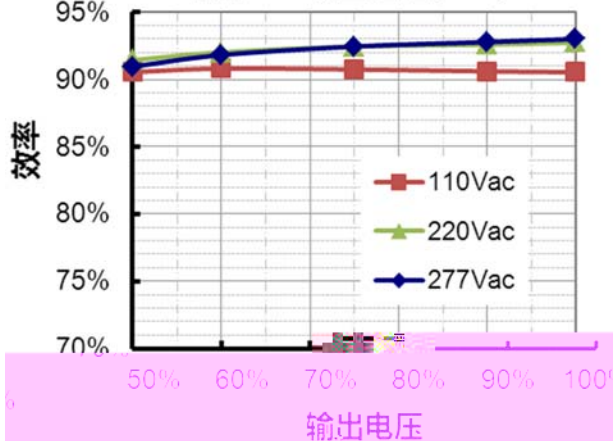

效率 vs. 输出电压(48V)

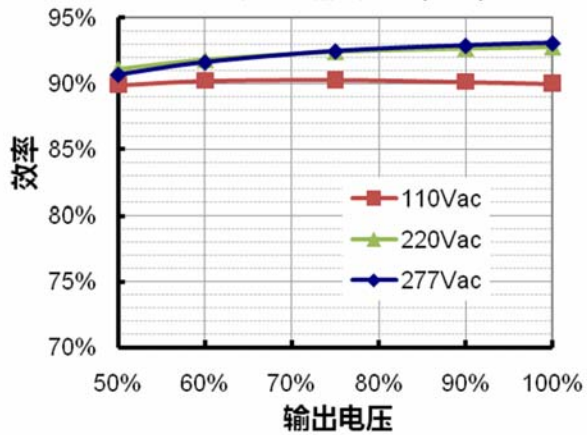

效率 vs. 输出电压(54V)

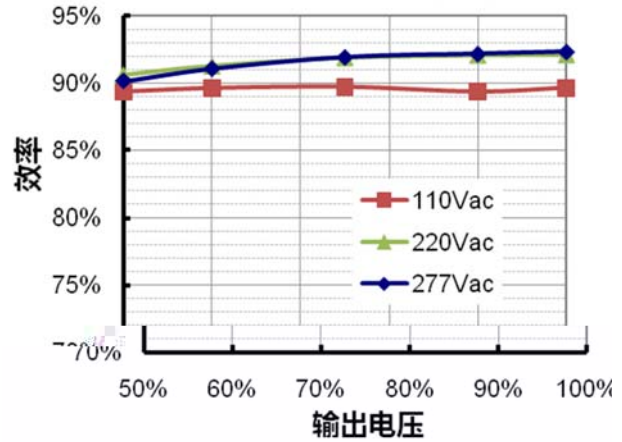

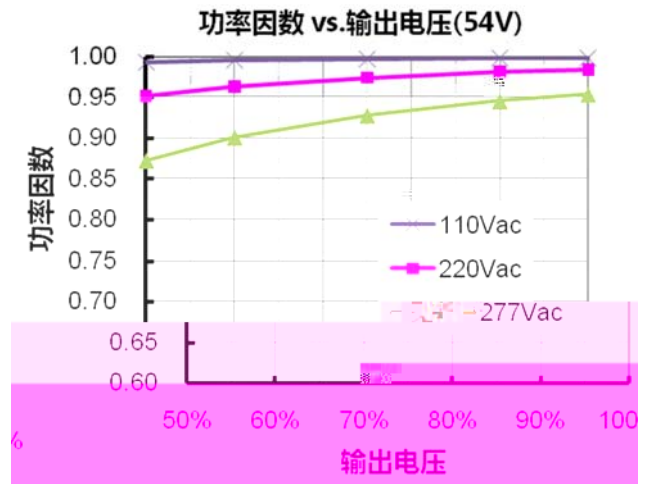
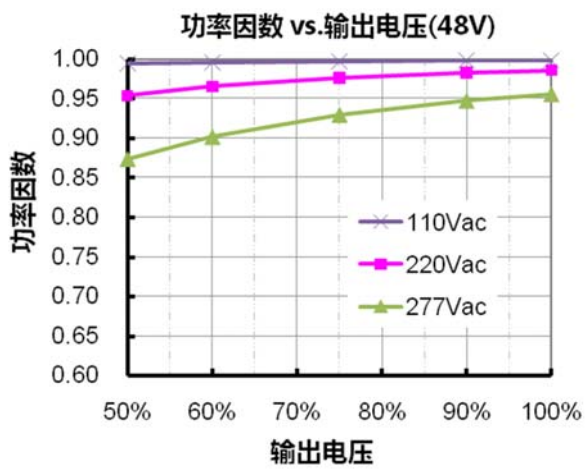
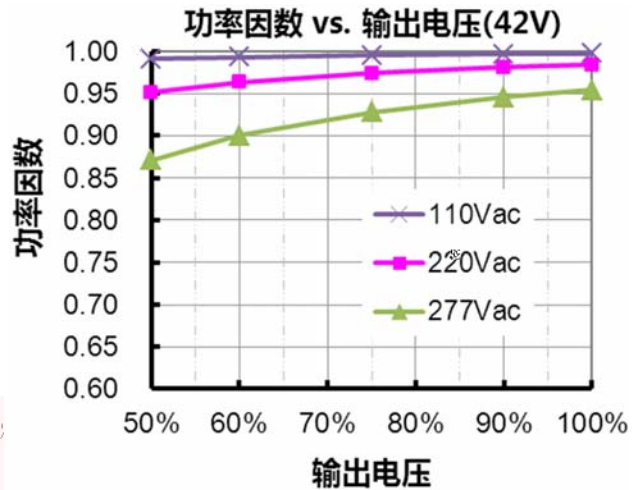
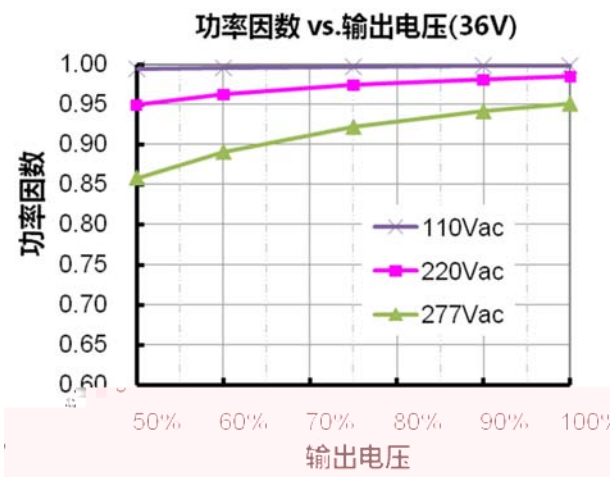
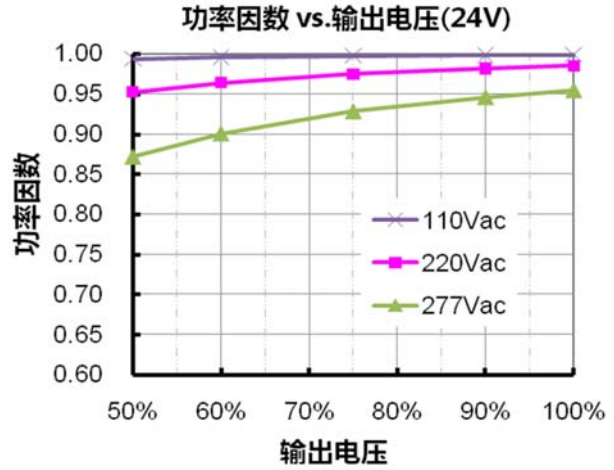
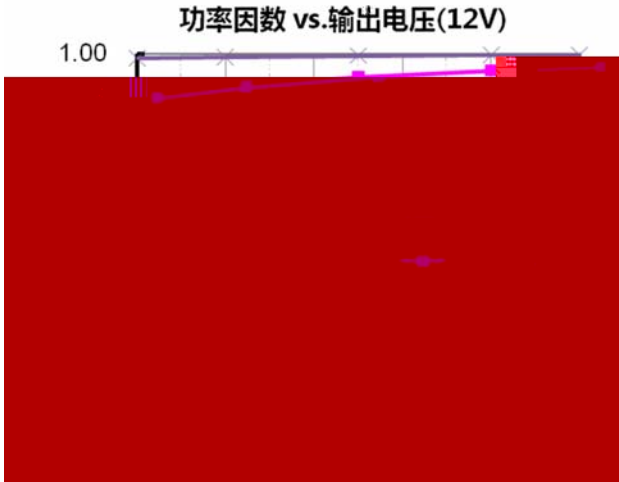

24V

EUV-200S012ST

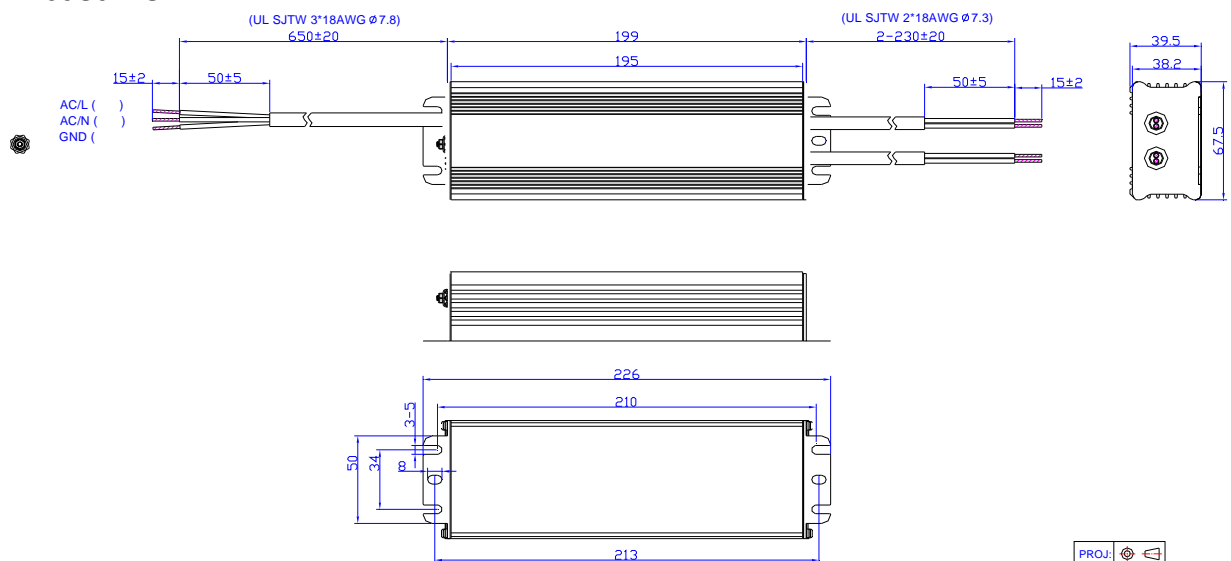

PROJ: ± 1

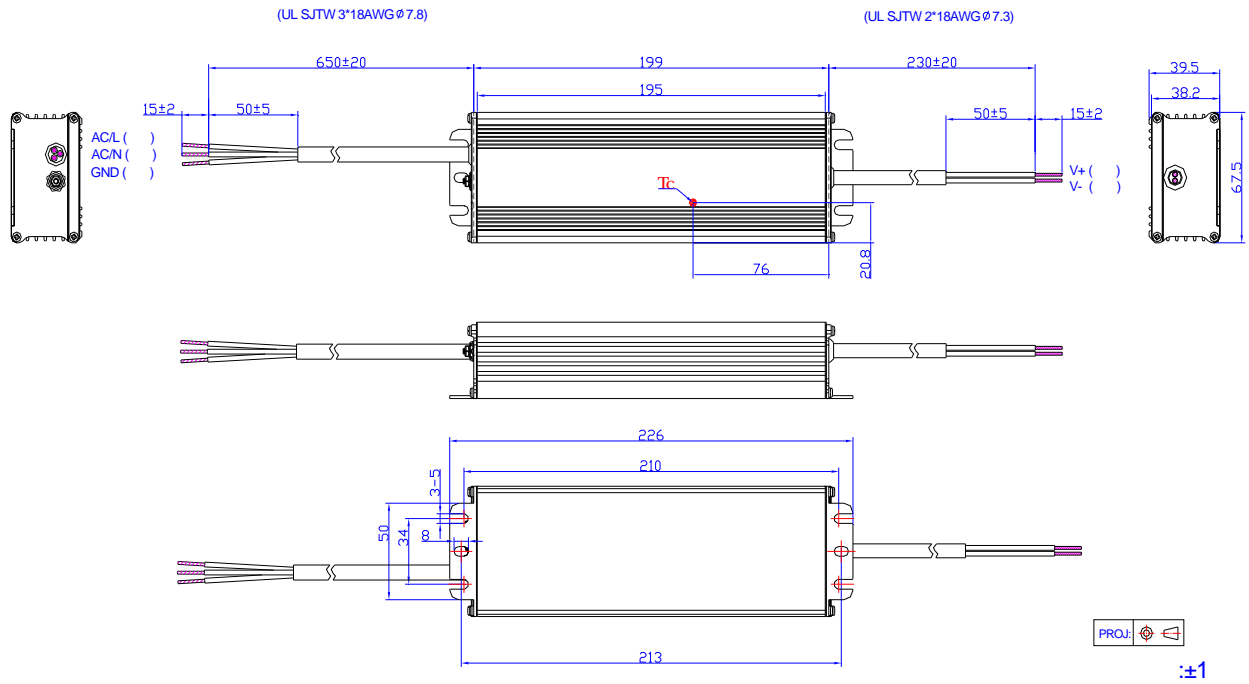

RoHS

2012-02-28	A					
2012-06-12	B					
2012-7-12	C					
2012-7-12	E					
2012-8-31	F					
			Typ 1.3lo	Max 1.7lo	Typ 1.4lo	Max 1.8lo
				247,000 Hrs		200,000 Hrs
		EN61000-4-5		line to line 2 kV, line to earth 4 kV		line to line 4 kV, line to earth 6 kV
2012-12-06	G					
2012-12-28	H					
2013-11-26	I					
2015-09-11	M					

2015-09-11	M			
2016-03-31	N			
2017-11-14	O			
			°	°
2019-03-12	P			
2020-01-06	Q			

2020-01-06	Q		EN 55015 ⁽¹⁾	EN 55015/KN 15 ⁽¹⁾
			EN 61000-4-5	
		RoHS		