

-
-
-
-

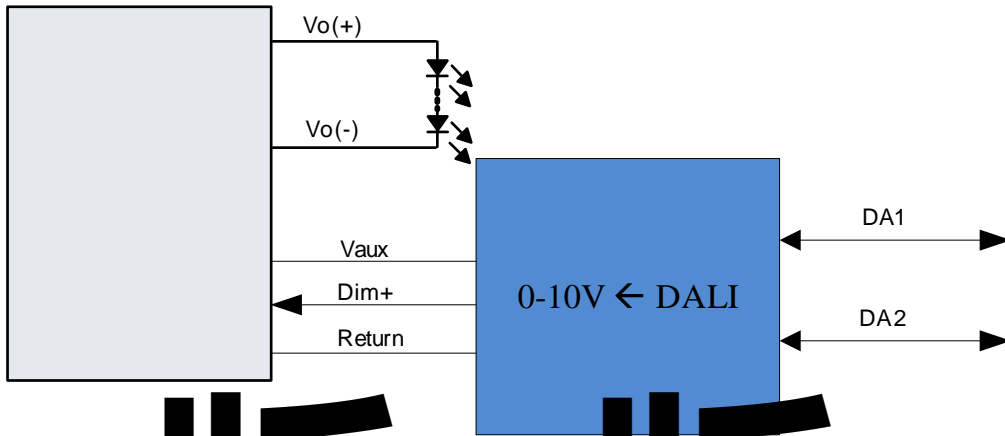







版 版

	10V	12V	24V	
	9.5V	-	10V	
	-	-	20mA	
	-	-	10mA	
	9.5V	16V	22.5V	
	-6.5V	0V	6.5V	
	0mA	-	2mA	

	0V	-	10V	Vaux 11.5V
	0V	-	(Vaux-1.2)V	9.5V Vaux 11.5V
	0mA	-	15mA	

修修

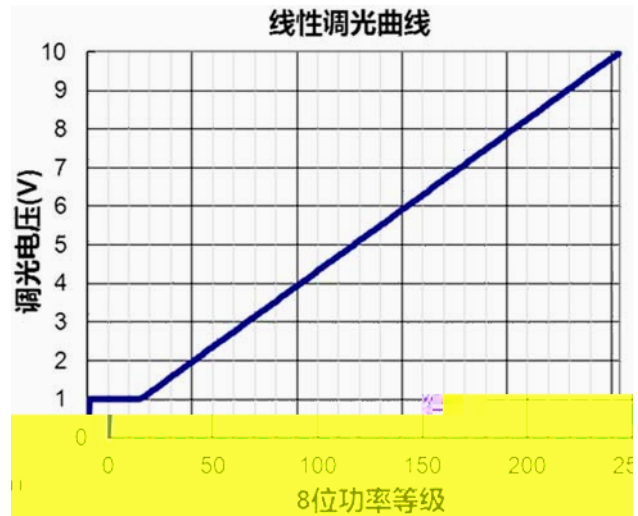
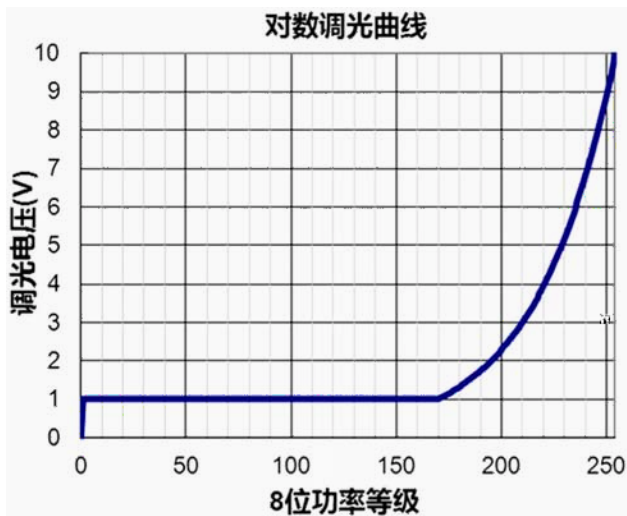

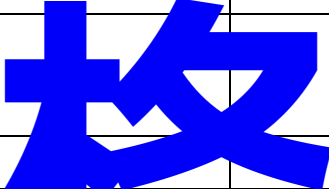
	-20 °C	-	+90 °C	
				

UL/CUL	UL8750,CAN/CSA-C22.2 No. 250.13
CE	EN 61347-1, EN61347-2-11
EN 55015 ⁽¹⁾	Conducted emission Test & Radiated emission Test
FCC Part 15 ⁽¹⁾	ANSI C63.4 Class B
	This device complies with Part 15 of the FCC Rules. Operation is subject to the following two conditions: [1] this device may not cause harmful interference, and [2] this device must accept any interference received, including interference that may cause undesired operation.
EN 61547	Electromagnetic Immunity Requirements Applies To Lighting Equipment

SDD-ADFN1

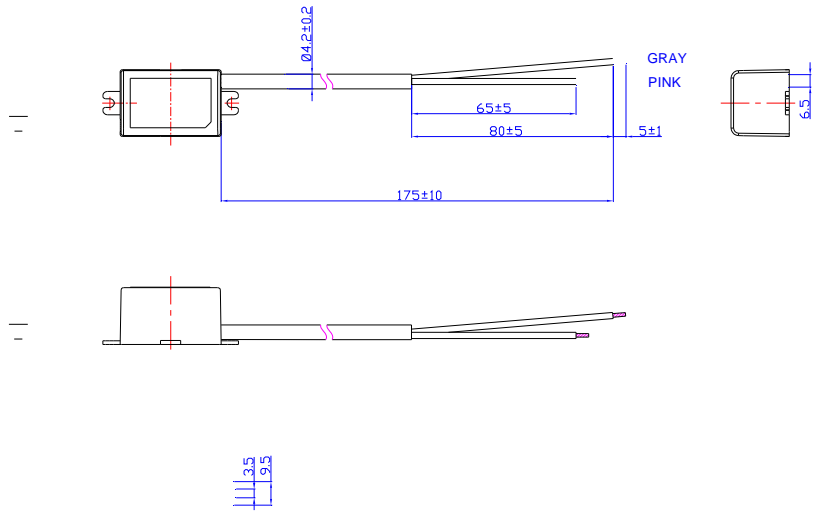

SDD-ADFN3

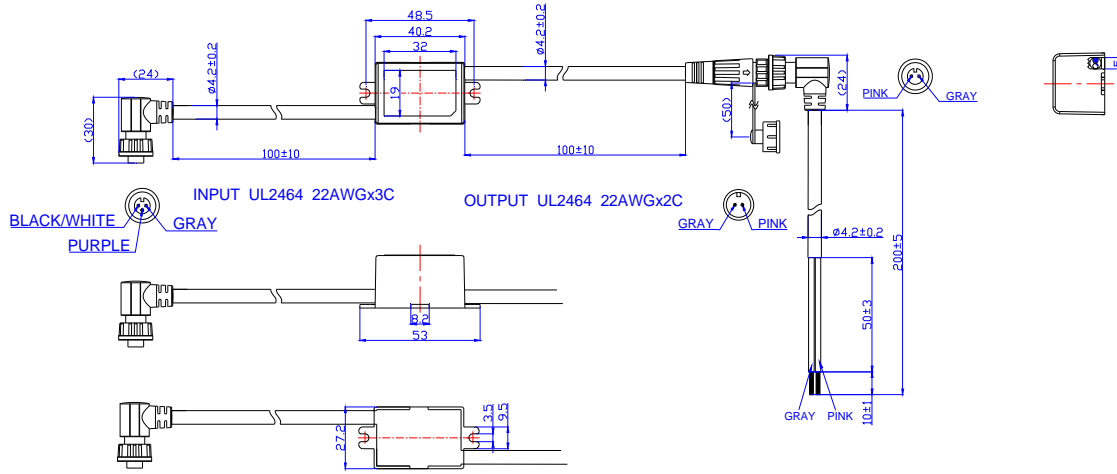

Unspecified tolerance:±1

SDD-ADFN5

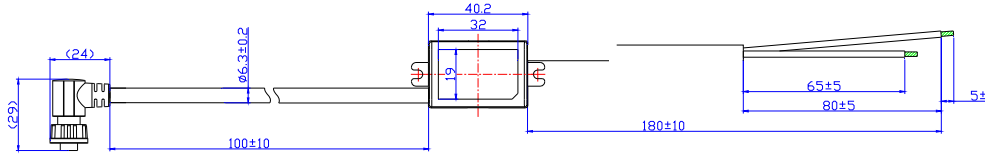

INPUT VDE $3 \times 0.5 \text{mm}^2$

OUTPUT VDE $2 \times 0.5 \text{mm}^2$

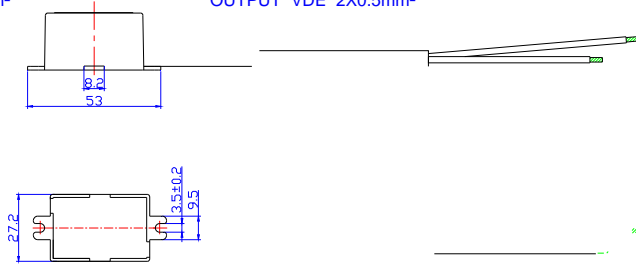

PROJ

Unspecified tolerance: ± 1

版 版

版 版

8	YAAA AAA1 0000 1000	
9	YAAA AAA1 0000 1001	
10 11	YAAA AAA1 0000 101X	
12 15	YAAA AAA1 0000 11XX	
16 31	YAAA AAA1 0001 XXXX	
32	YAAA AAA1 0010 0000	
33	YAAA AAA1 0010 0001	
34 35	YAAA AAA1 0010 001X	
36 39	YAAA AAA1 0010 01XX	
40 41	YAAA AAA1 0010 100X	
42	YAAA AAA1 0010 1010	
43	YAAA AAA1 0010 1011	
44	YAAA AAA1 0010 1100	
45	YAAA AAA1 0010 1101	
46	YAAA AAA1 0010 1110	
47	YAAA AAA1 0010 1111	
48 63	YAAA AAA1 0011 XXXX	
64 79	YAAA AAA1 0100 XXXX	
80 95	YAAA AAA1 0101 XXXX	
96 111	YAAA AAA1 0110 XXXX	
112 127	YAAA AAA1 0111 XXXX	
128	YAAA AAA1 1000 0000	
129	YAAA AAA1 1000 0001	
130 131	YAAA AAA1 1000 001X	
132 135	YAAA AAA1 1000 01XX	
136 143	YAAA AAA1 1000 1XXX	
145	YAAA AAA1 1001 0001	
148	YAAA AAA1 1001 0100	
149	YAAA AAA1 1001 0101	
150	YAAA AAA1 1001 0110	
151	YAAA AAA1 1001 0111	
152	YAAA AAA1 1001 1000	

153	YAAA AAA1 1001 1001	
154	YAAA AAA1 1001 1010	
155	YAAA AAA1 1001 1011	
156	YAAA AAA1 1001 1100	
157	YAAA AAA1 1001 1101	
158 159	YAAA AAA1 1001 111X	
161	YAAA AAA1 1010 0001	
162	YAAA AAA1 1010 0010	
163	YAAA AAA1 1010 0011	
164	YAAA AAA1 1010 0100	
165	YAAA AAA1 1010 0101	
166 167	YAAA AAA1 1010 011X	
168 175	YAAA AAA1 1010 1XXX	
176 191	YAAA AAA1 1011 XXXX	
192	YAAA AAA1 1100 0000	
193	YAAA AAA1 1100 0001	
194	YAAA AAA1 1100 0010	
195	YAAA AAA1 1100 0011	
196	YAAA AAA1 1100 0100	
197	YAAA AAA1 1100 0101	
198 199	YAAA AAA1 1100 011X	
200~207	YAAA AAA1 1100 1XXX	
208~215	YAAA AAA1 1101 0XXX	
216 223	YAAA AAA1 1101 1XXX	
227	YAAA AAA1 1110 0011	
228	YAAA AAA1 1110 0100	
229	YAAA AAA1 1110 0101	
230 - 231	YAAA AAA1 1110 011X	
232 - 235	YAAA AAA1 1110 10XX	
236	YAAA AAA1 1110 1100	
238	YAAA AAA1 1110 1110	
253	YAAA AAA1 1111 1101	

•

254	YAAA AAA1 1111 1110	
255	YAAA AAA1 1111 1111	
256	1010 0001 0000 0000	
257	1010 0011 XXXX XXXX	
258	1010 0101 XXXX XXXX	
259	1010 0111 0000 0000	

选择

选择
