

- 89%
- 312~ 528Vac
- 0.95
- 0-10V
- IP66 UL
- Class 2



LTC-040SxxxDSP(SSP) 40W

312~ 528Vac

					347Vac	480Vac	

- 1 UL,FCC 347~ 480Vac
- 2 480Vac, 100%
- 3 Class 2 &
- 4 Class 2 &

	312 Vac	-	528 Vac	
	47 Hz	-	63 Hz	
	-	-		

	-	-	0.17 A	347Vac 100%
	-	-	0.13 A	480Vac 100%
I <sup>2</sup> t	-	-	0.32 A <sup>2</sup> s	480Vac 25 10%-10% = 120 μ
	0.9	-	-	347~480 Vac 75%~100%
	-	-	20%	

				10uF : 20MHz 0.1uF
/				
				100%
				100%
				347Vac
				480Vac
		°		=0° ~Tc
12Vaux				
12Vaux				

25°C

@				°C .
@				°C .
				°C (MIL-HDBK-217F)
				°C
	°C		°C	
	°C		°C	:
	°C		°C	:
	-		-	

25°C

1 EMI

( ) EMI

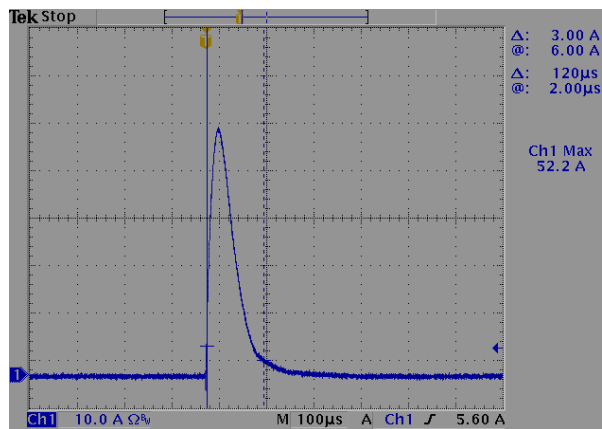
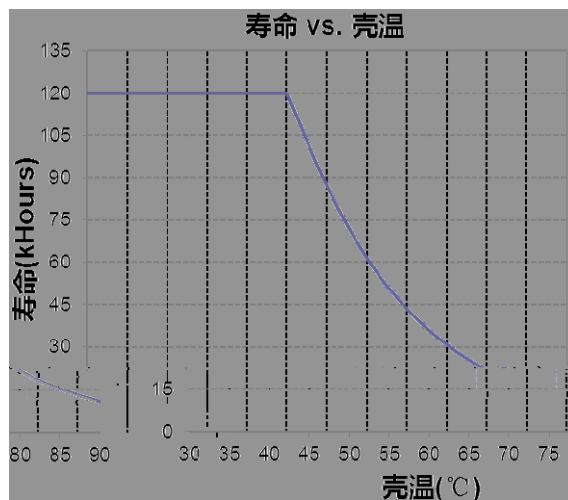

LTC-040S035DSP(SSP)

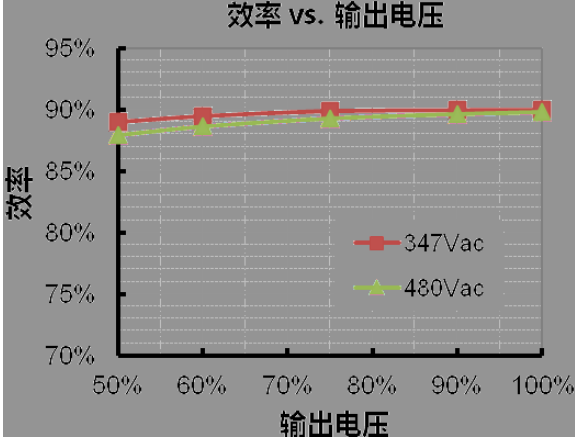

LTC-040S053DSP(SSP)

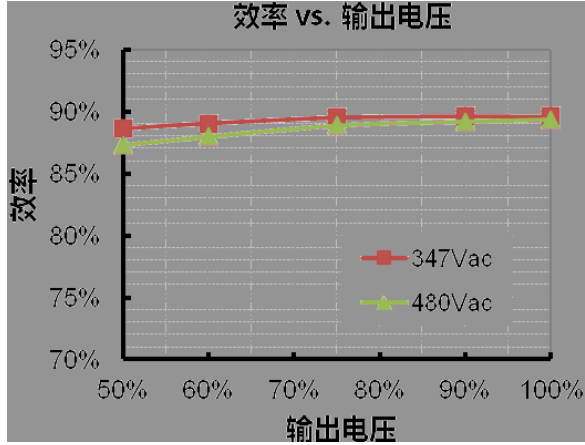

LTC-040S070DSP(SSP)

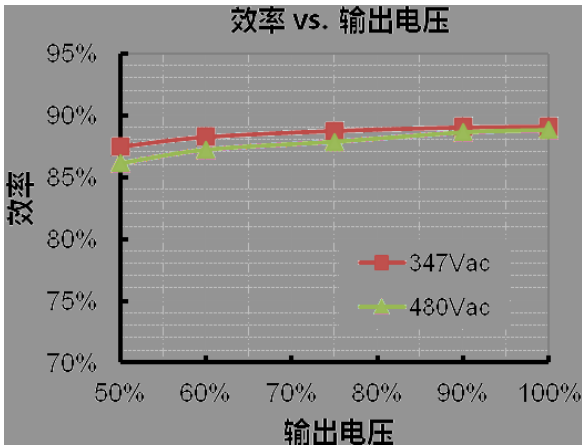

LTC-040S105DSP(SSP)

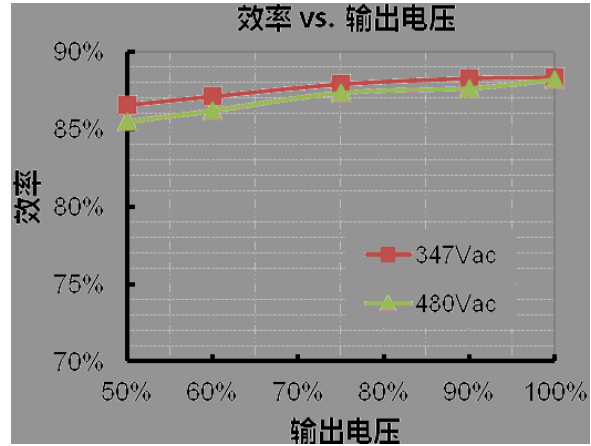

LTC-040S140DSP(SSP)

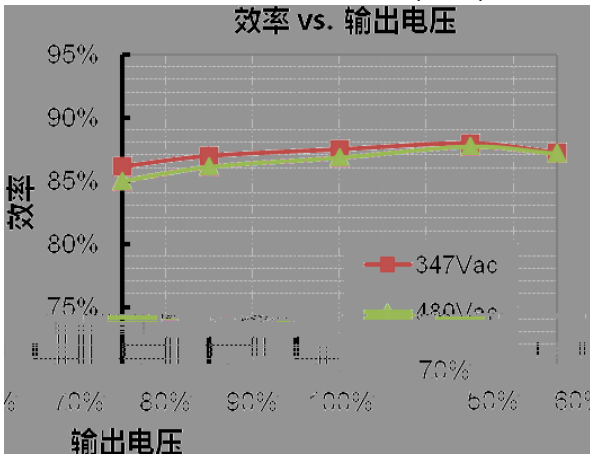

LTC-040S175DSP(SSP)

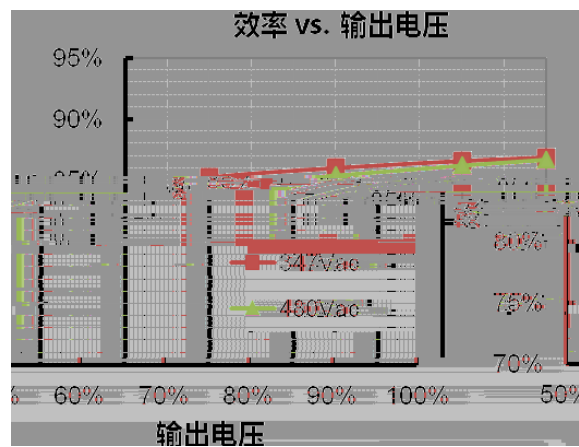

LTC-040S210DSP(SSP)

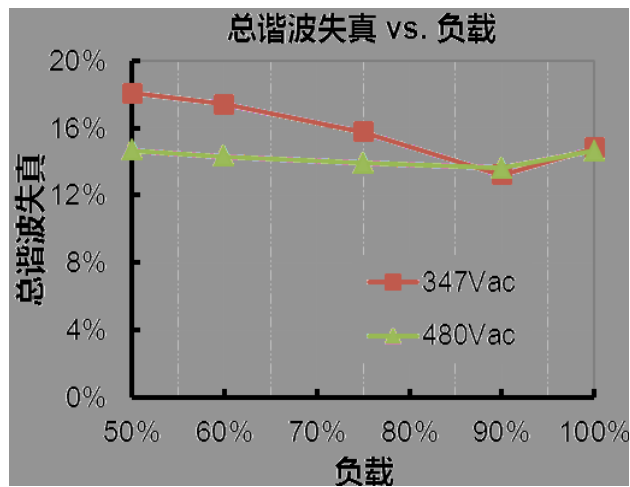
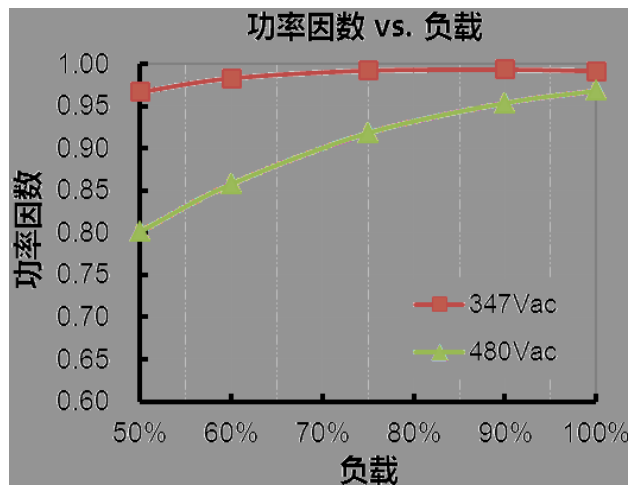
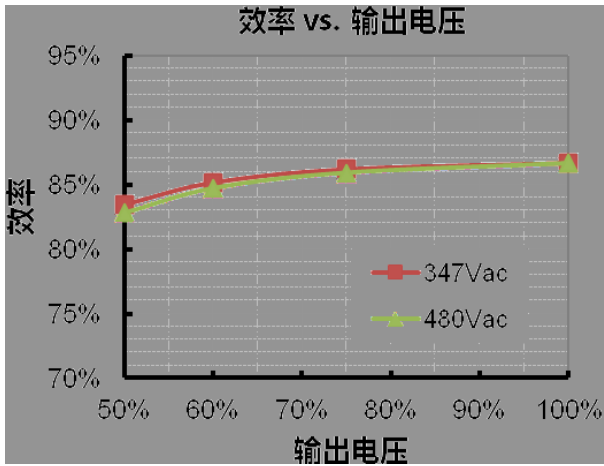

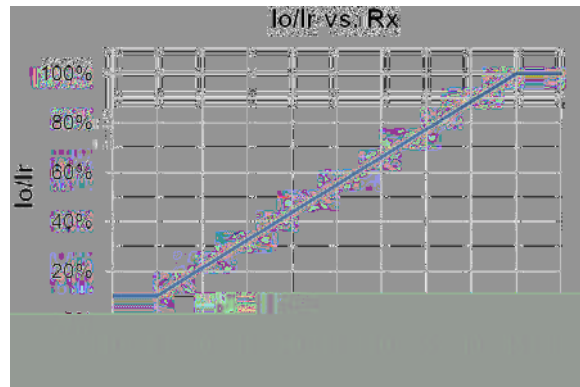
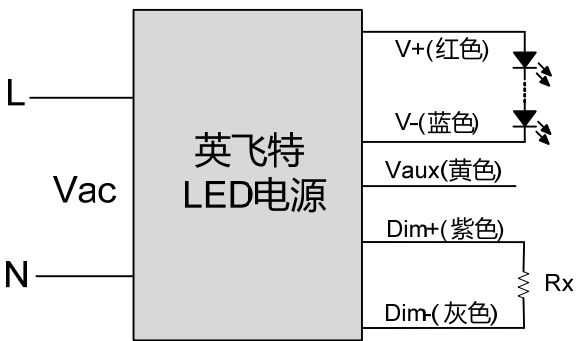
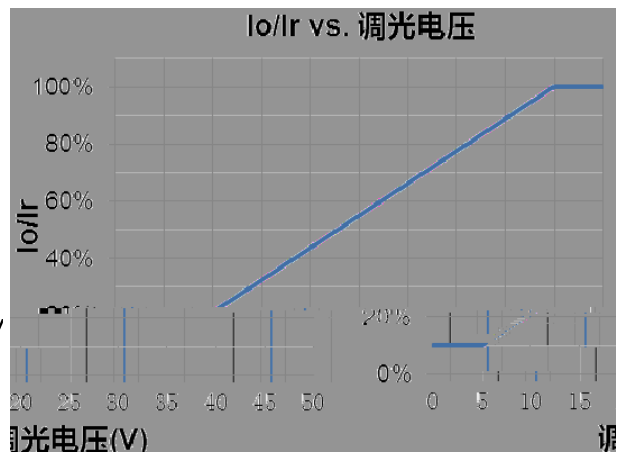
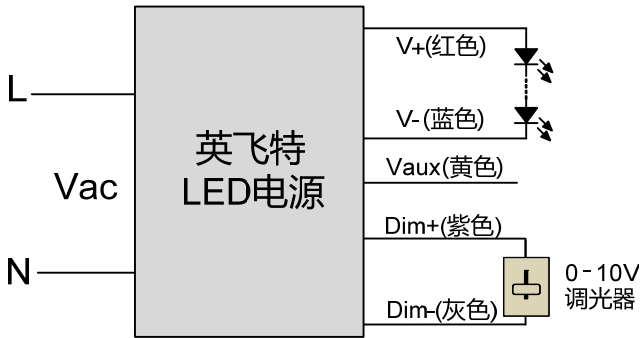

● 0-10V

0-10V

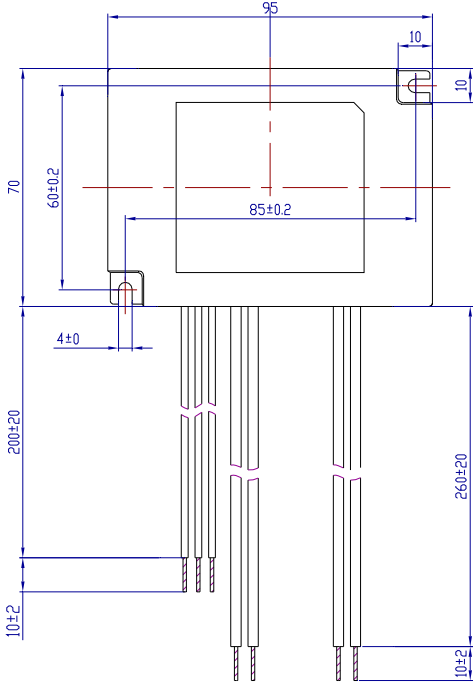

1.  $I_o$                        $I_r$
2.                              Dim-                      V-      V+
3.                                      Dim+                      Vaux

**LTC-040SxxxDSP**



**LTC-040SxxxSSP**

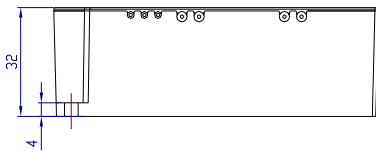



			/	/
			/	
			/	
		0-10V	/	
		0~ 10V		
		-Tc	/	