

CNV-DMXR

	1
1	1
1.1	1
1.2	1
1.3	1
2	2
2.1	2
2.2	2
3	3
3.1	3
3.2	3
4	4
4.1	4
5	5
5.1	5
5.1.1	USB	5
5.1.2	7
6	8

6.1	8
6.2	9
6.3	10
6.4	11
6.5 DMX512	12
6.6 DMX512	13
6.7 DMX512	14
6.8	15

1

1.1

CNV-DMXR

1.2

DMX512

(USITT)

CNV-DMXR

DMX512

0-10V

RDM

CNV-DMXR

1.3

DMX (Digital Multiple X)

DMX512: **512**

RDM (Remote Device Management)

DMX512-A

CNV-DMXR **DMX512**

0-10V

2.

2.1

2.2

- 1.
- 2.
3. DMX512
4. DMX512
- 5.

3.

3.1

1GHz 32

512Mb RAM

20GB

UTEK UT890

CNV-DMXR

3.2

Windows XP Windows 7

Microsoft .NET Framework 4.0

4

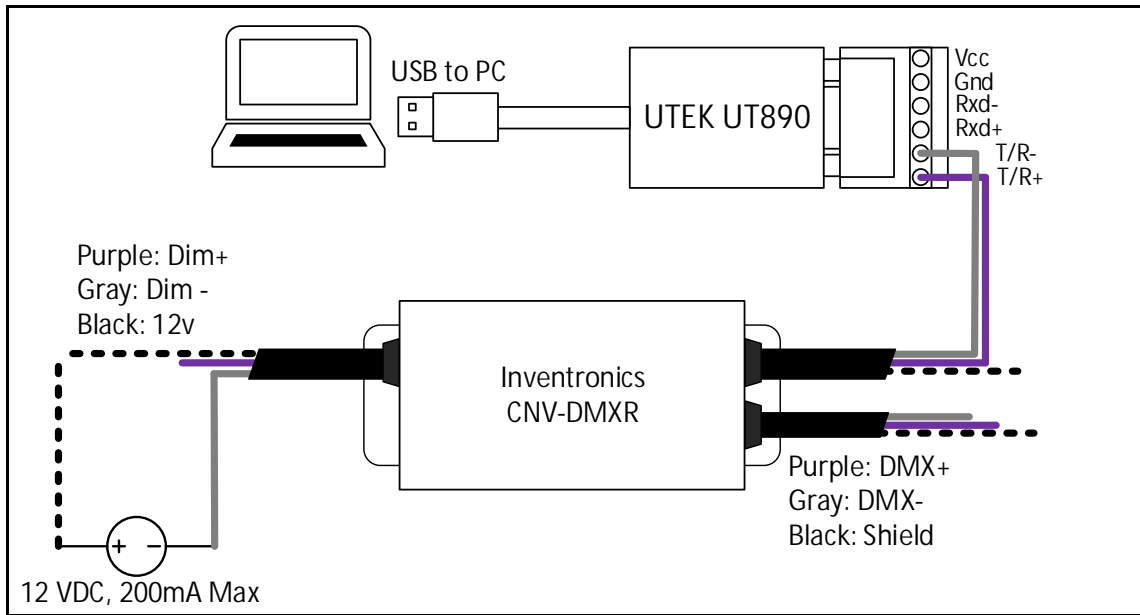

4.1

1. CNV-DMXR UTEK UT890

a. CNV-DMXR Data+ UTE890 T/R+

b. CNV-DMXR Data- UTE890 T/R-

* CNV-DMXR DMX UT890

c. Dim- DC 12VDC- 12VDC-

d. Vaux DC 12VDC+ 12VDC-

e. CNV-DMXR 200mA

2. CNV-DMXR

5.

5.1

5.1.1 USB

1. USB_MCom.rar
2. USB_MCom.exe
- 3.

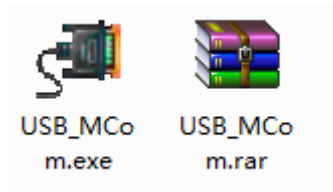

4.4.1.1 USB

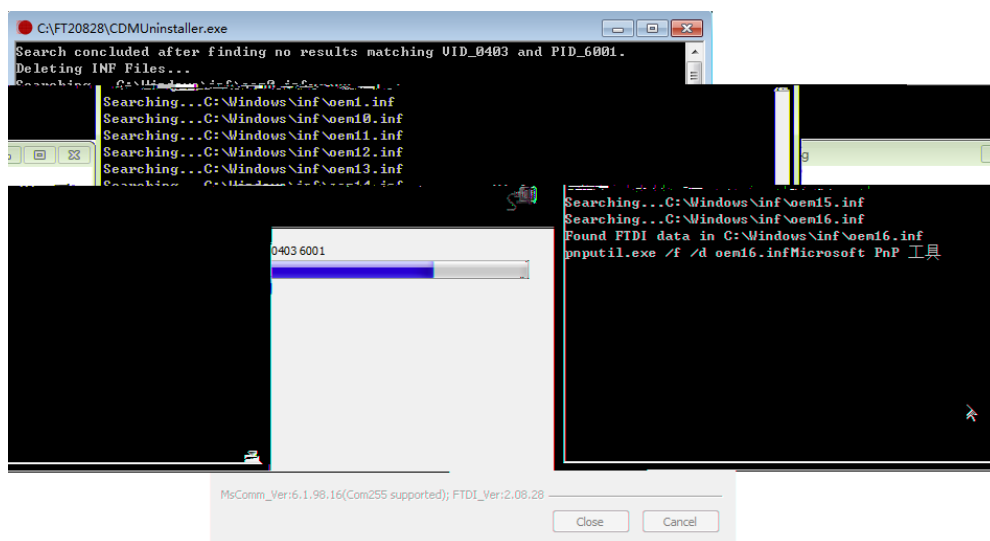

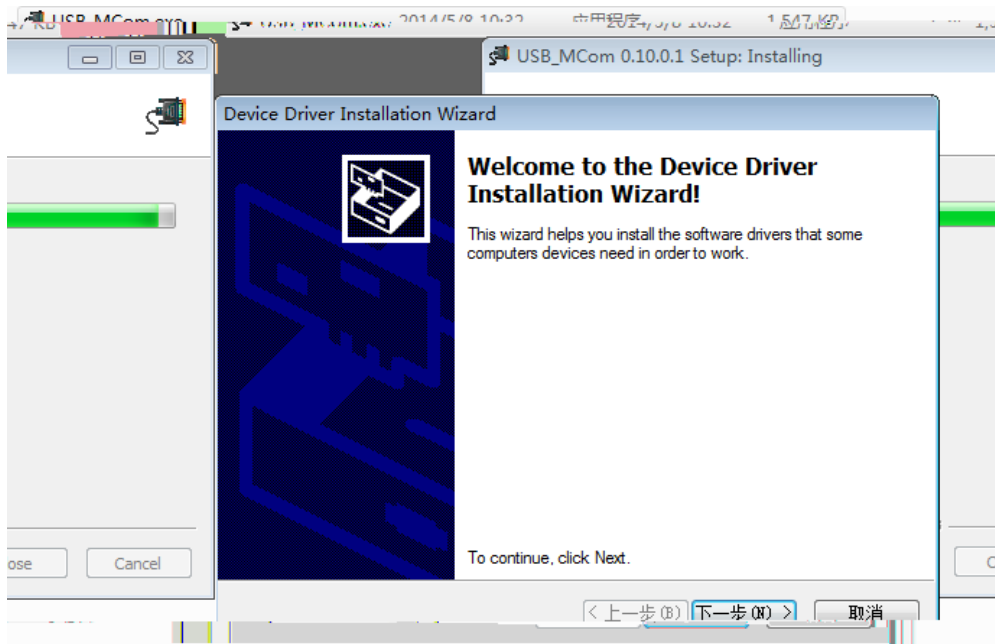

5.1.2

1.

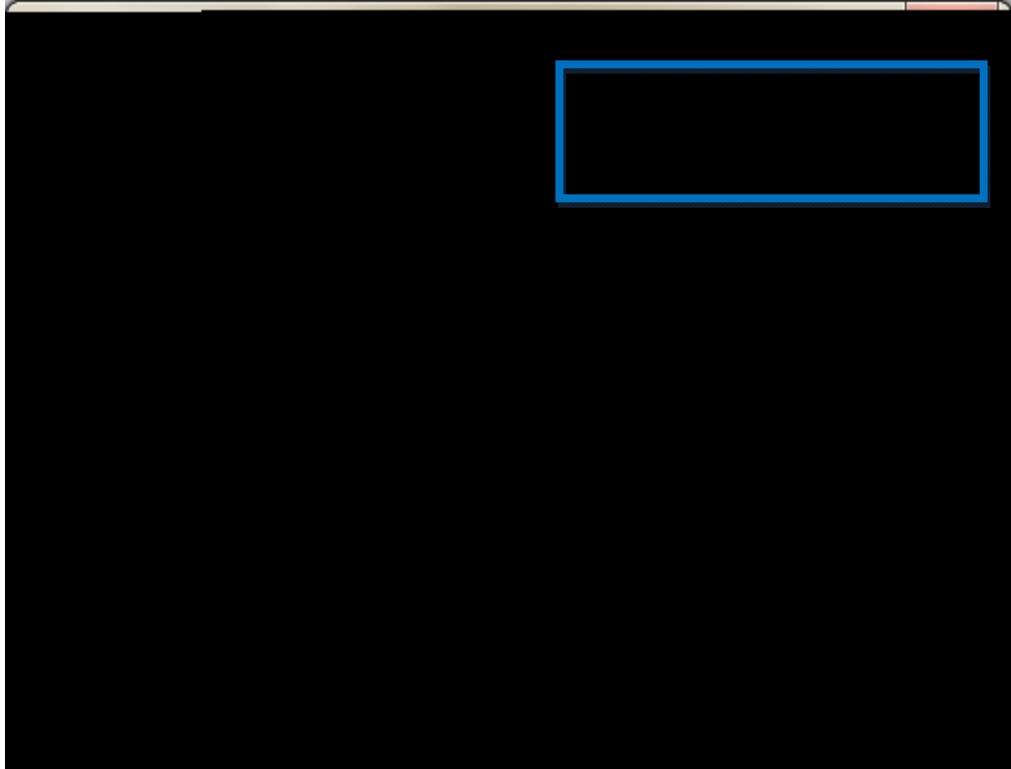

2. PC Microsoft .NET Framework 4.0

<https://www.microsoft.com/zh-cn/download/details.aspx?id=17718>

6.

6.1

6.2

COMx x
USB
Port

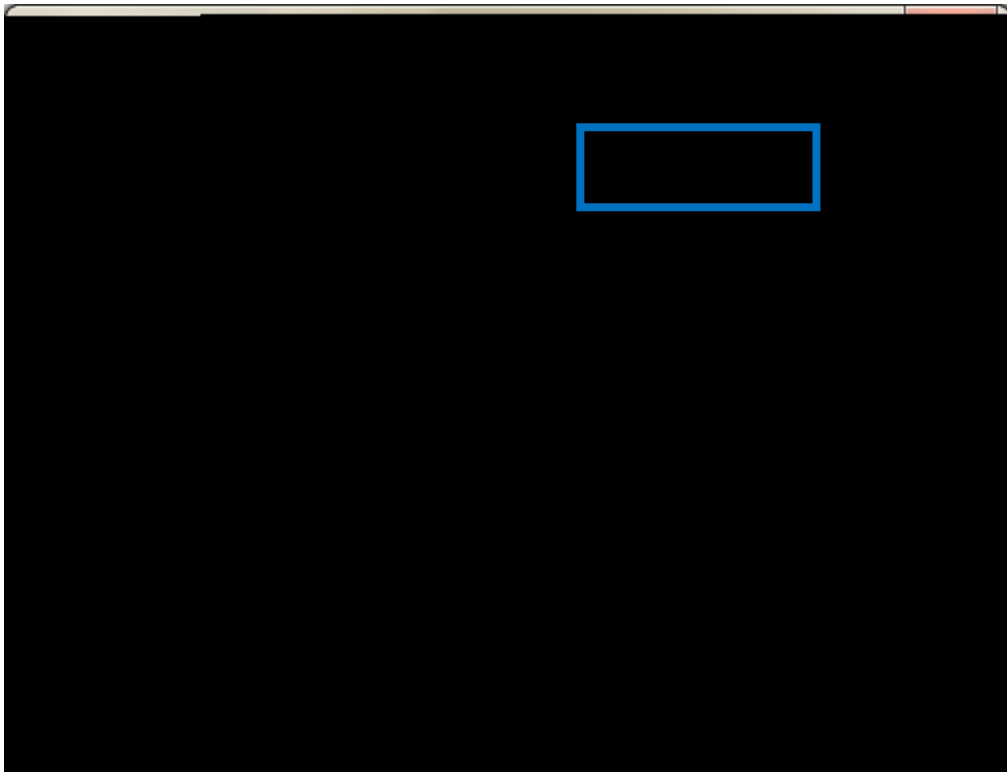

6.3

- 1 Read Curve ()
- 2 CNV-DMXR
- 3

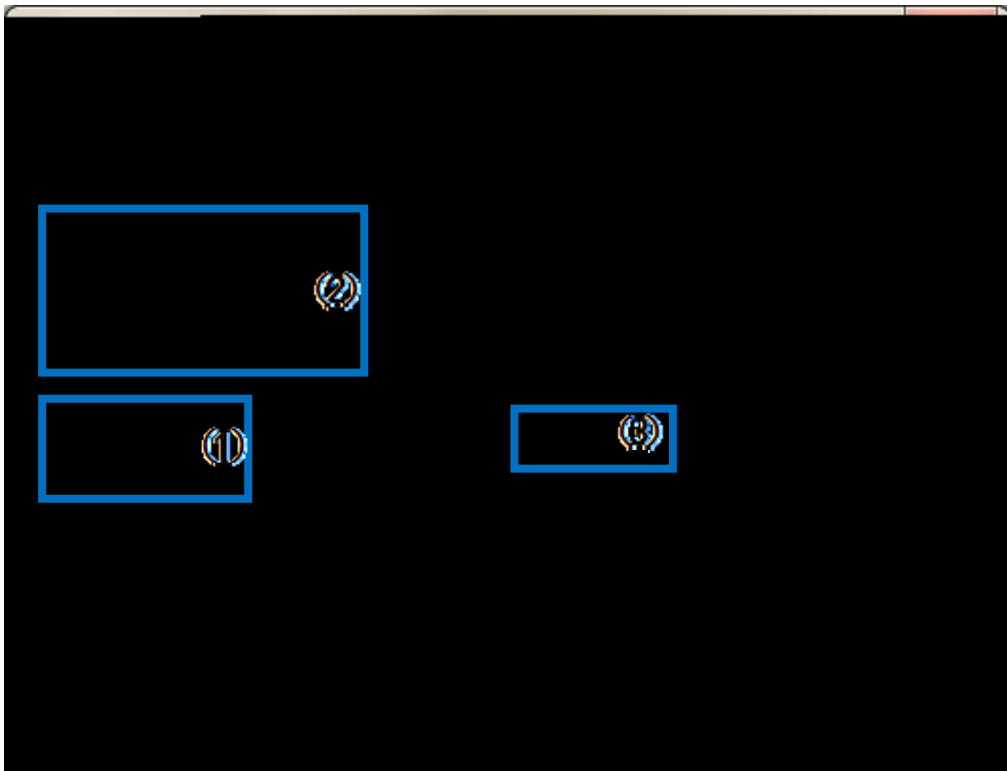

6.4

1

2 Write Curve ()

3

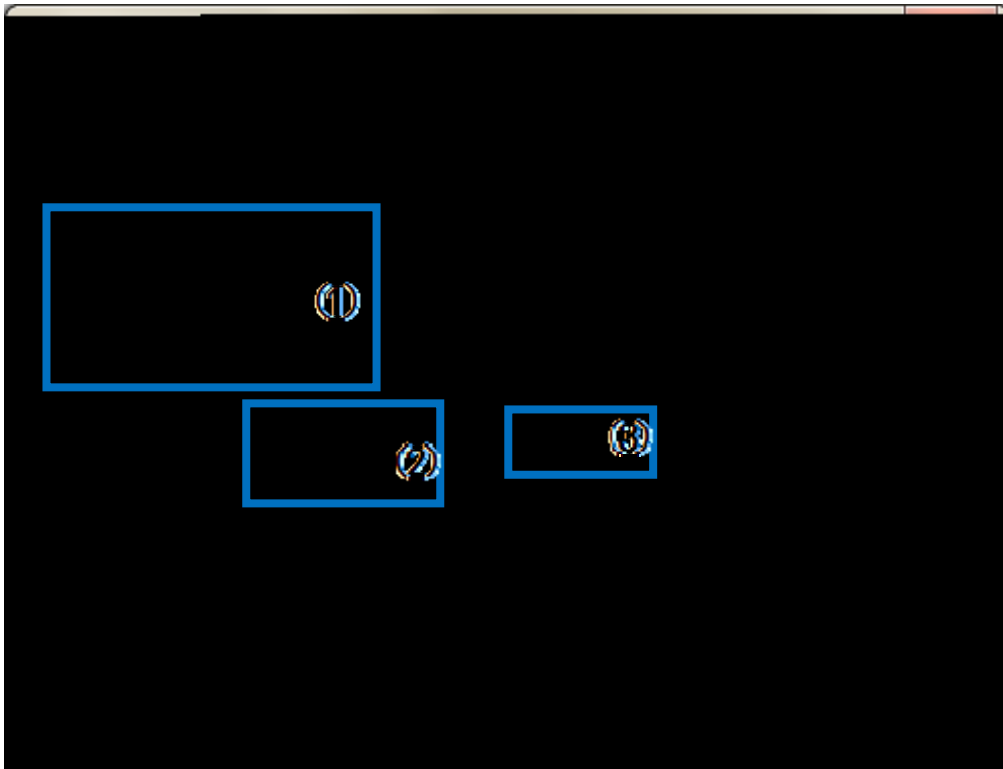

6.5 DMX512

- 1 Read Address ()
- 2 CNV-DMXR
- 3

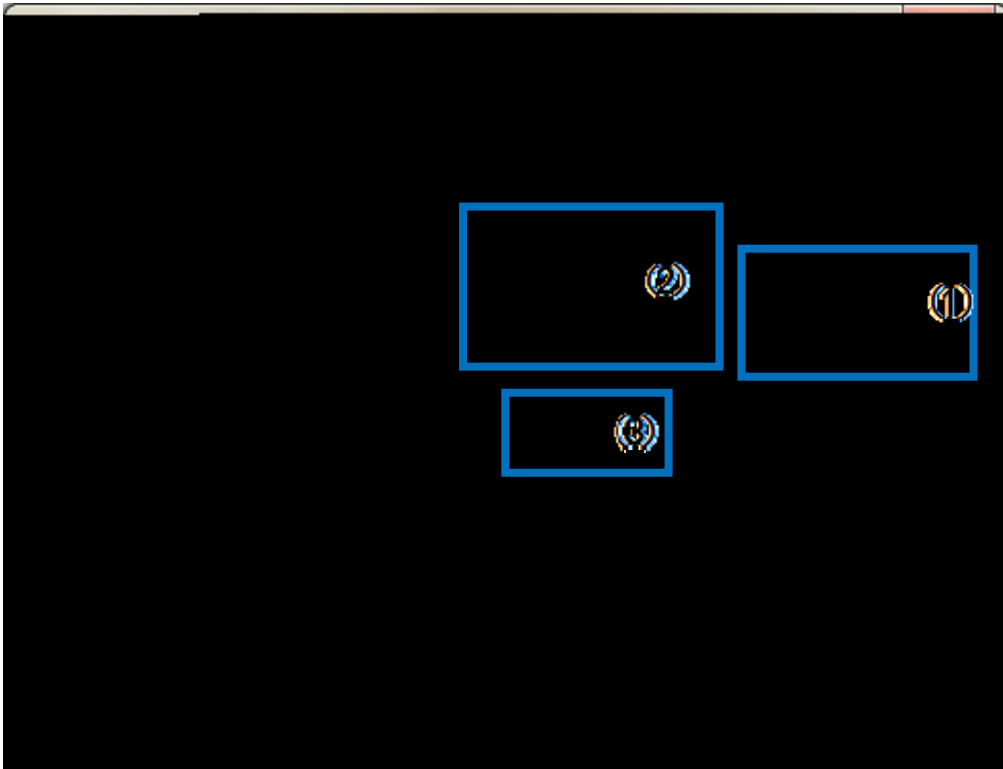

6.6 DMX512

- 1 DMX512
- 2 Write Address ()
- 3

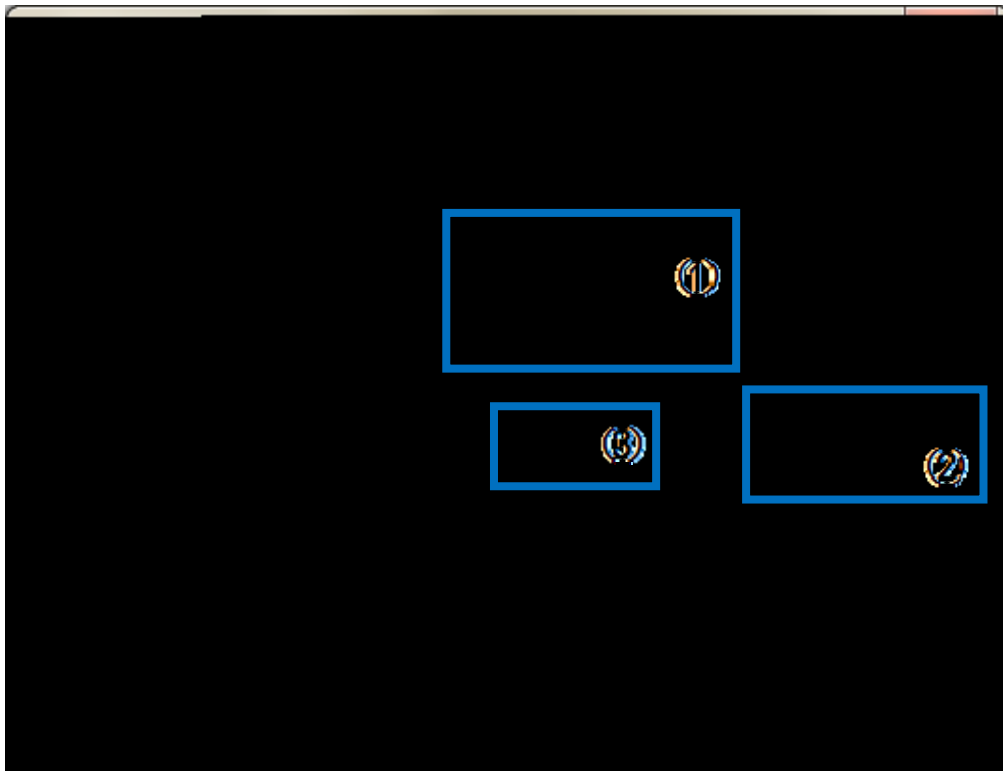

6.7 DMX512

1

2

3 Dimming()

4

1 512 ()
() 0

2 CNV-DMXR DMX512

[5.5 DMX512](#)

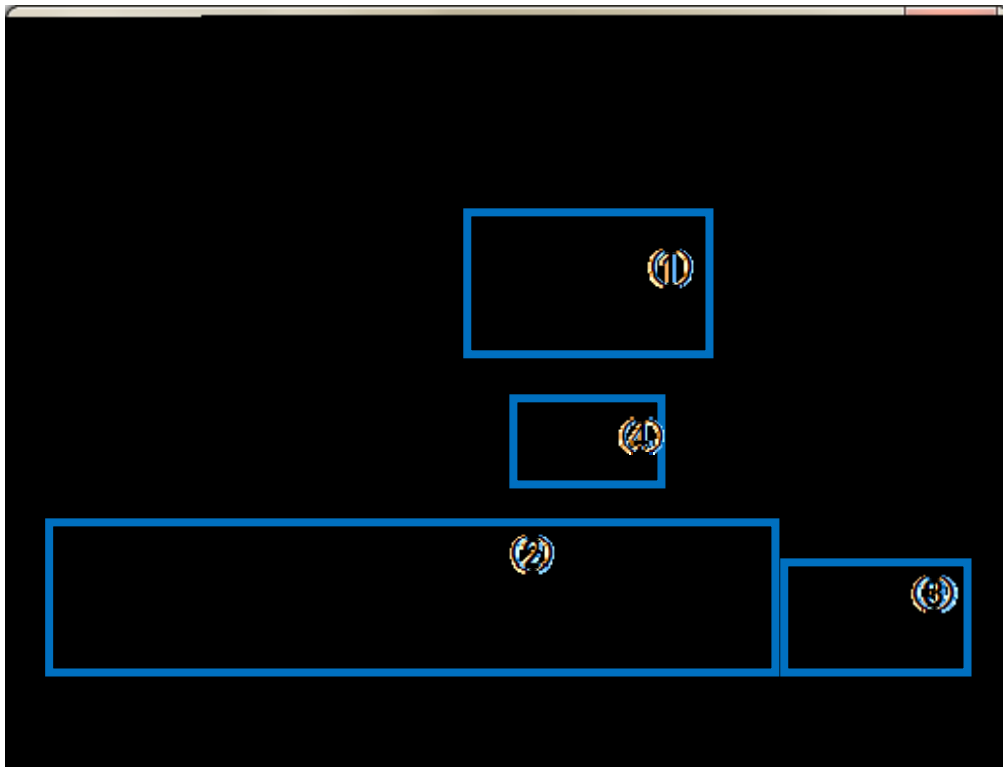

6.8

CNV-DMXR

Alt

- 1 Read Address () R
- 2 Write Address () W
- 3 Dimming () D
- 4 F1

